



M10 / PM004

Looking equally smart from all angles thanks to its completely finished arm, the M10 is the perfect 10. Relax and reflect in comfort with this friendly, outstanding style with padded arms echoing the lines of the headrest. Be moved by its motion possibilities, and complete this look with a choice of polished chrome leg or wood leg in rich onyx or walnut to match the table options.

PINNACLE
SEATINGSTUDIO.COM™

OPTIONS

Leg:

Wood



ONYX

Metal



POLISHED
STEEL

Table:

Wood



ONYX

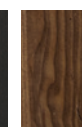

WALNUT

Covers:

- All over leather
- All over Ultrasuede®

Power:

- Power headrest included with power mech
- Manual headrest included with stationary pieces

Seats:

- Tight with attached seat

Backs:

- Tight with attached back
- Premium 2.2 lb high-density foam

FEATURES

- Premium 2.2 lb high-density foam seats
- High density foam backs
- Engineered wood, hardwood and softwood; all joints pinned and glued for uniformity and strength
- Adjustable articulating headrests

M10 / PM004

Dimensions shown as Width x Depth x Height. Specifications are correct at time of printing and are subject to change without notice.
LHF - left hand facing | RHF - right hand facing | IA - Inside arm to inside arm

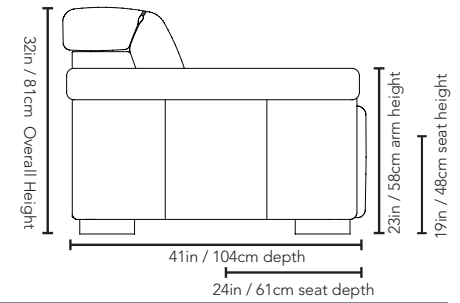

PIECES

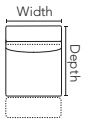

***2P - Armless Wide Recliner, Power**
34in x 41in x 32in
86cm 104cm x 81cm

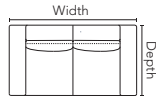

03 - Stationary Loveseat
75in x 41in x 32in
191cm x 104cm x 81cm
IA = 51in / 130cm

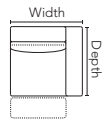

6P - RHF Wide Recliner, Power
7P - LHF Wide Recliner, Power
46in x 41in x 32in
117cm x 104cm x 81cm

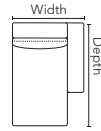

6L - RHF Chaise, Long
7L - LHF Chaise, Long
46in x 67in x 32in
117cm x 170cm x 81cm

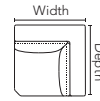

9A - Corner Square with Moveable Headrests
9H - Corner Square with Headrests
47in x 47in x 32in
119cm 119cm x 81cm

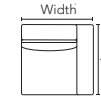

15 - RHF Wide Stationary End
16 - LHF Wide Stationary End
46in x 41in x 32in
117cm x 104cm x 81cm

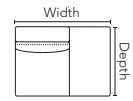

17 - RHF Stationary Nest
18 - LHF Stationary Nest
58in x 41in x 32in
147cm x 104cm x 81cm

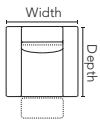

31 - Wallhugger Recliner, Power
50in x 41in x 32in
127cm x 104cm x 81cm
IA = 25in / 64cm

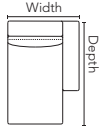

56 - RHF Chaise
57 - LHF Chaise
46in x 63in x 32in
117cm x 160cm x 81cm

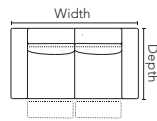

63 - Loveseat Recliner, Power
75in x 41in x 32in
191cm x 104cm x 81cm
IA = 51in / 130cm

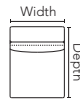

70 - Armless Wide Chair
34in x 41in x 32in
86cm x 104cm x 81cm

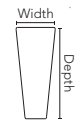

T0 - Table Top Angled Wedge
18in x 41in x 21in
46cm x 102cm x 53cm

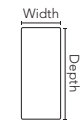

T2 - Table Top Console
13in x 41in x 21in
33cm x 102cm x 53cm

POPULAR CONFIGURATIONS

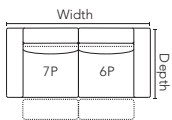

7P/6P

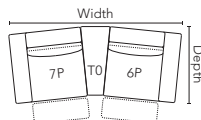

7P/T0/6P

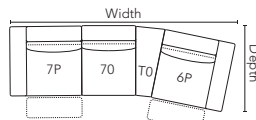

7P/70/T0/6P

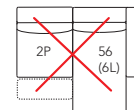

CAUTION:

*2P Wide Armless Recliner with power should not be connected to 56, 57, 6L and 7L Chaise without table top wedge in between.

Measurements apply to reclining pieces only.
Wall Clearance = 2in / 5cm
Depth in Full Recline = 65in / 164cm